

ASSEMBLY INSTRUCTION
VERGIL
SET OF 2 DINING CHAIRS
ITEM CODE 85815

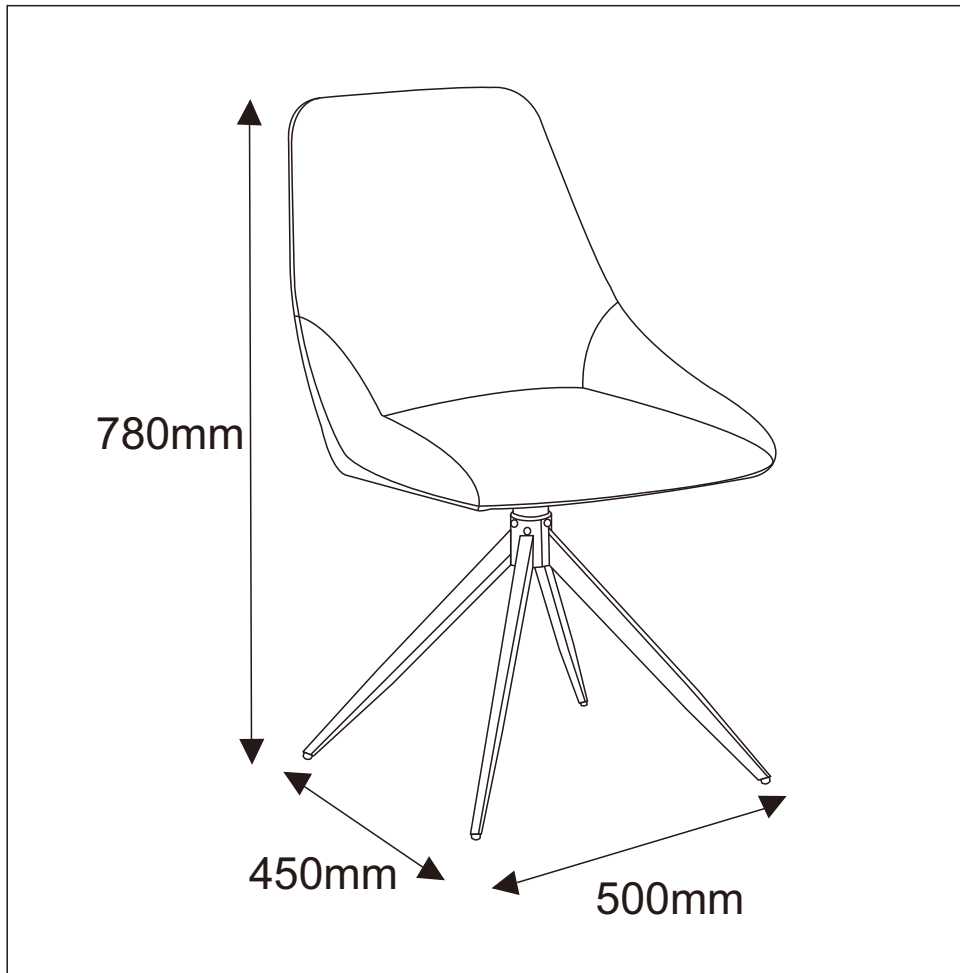



Imported by JWA Furniture Pty Ltd, Qld, Brisbane Australia.

For any assistance with assembly or for missing parts please refer to your receipt









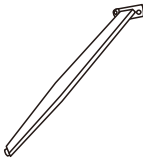
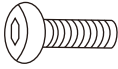

PRE-ASSEMBLY PREPARATION

Before you start:

1. Choose a clean, level, spacious assembly area. Avoid hard surfaces that may damage the product
2. Take care when lifting. Product should be assembled as near as possible to the point of use
3. Ensure that you have all required contents for complete assembly
4. Always read the assembly instructions carefully before beginning assembly.
5. Keep all hardware parts and packaging out of reach of small children.
6. Do not over tighten the screws and bolts as this may damage the threads

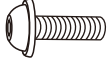
		
Allow 5 min	For 1 person	Additional tools required

PARTS LIST

A	B	C	D
			 8x16mm
1	1	4	8
E	F	G	H
 Φ8mm	 8x16x1.5mm	 6x25mm	 6x16mm
8	8	2	2
I	J	K	L
 Φ 6mm	 6x18x1.5mm	 M5	 8x22x7mm
4	4	1	2

STEP 1:

- Turn over the chair seat (A) over and put it on the protected surface
- Put the washers (L), the connecting part (B) and the chair legs (C) on the seat in the order shown in the picture

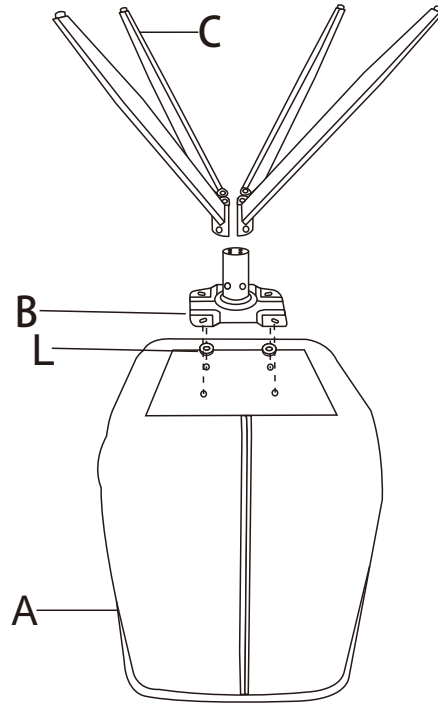

STEP 2:

- Tighten the screws (D) and washers (E) (F) on the chair legs (C) with Allen (K)
- Tighten the screws (G) (H) and washers (I) (J) the connecting part (B) with Allen (K)

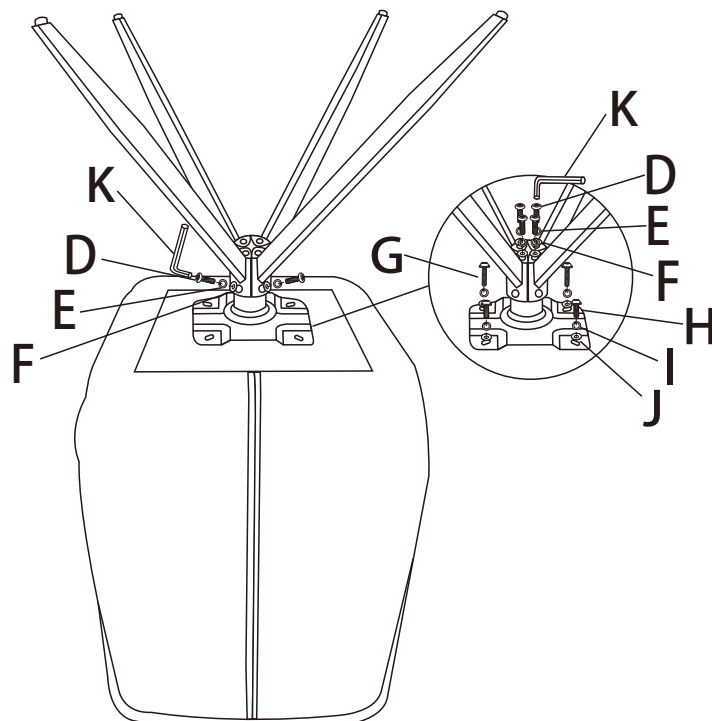

ASSEMBLY IS COMPLETE



CARE AND MAINTENANCE

REGULAR CARE:

- Protect from direct sunlight
- Vacuum regularly using low suction
- Rotate reversible cushions regularly
- Avoid exposure to new clothing, cushions or throws as this may lead to dye transfer and permanent staining

CLEANING:

- Do not remove cushion covers for separate cleaning even though they may have zippers• Do not wash, Do not dry clean, Do not shampoo clean
- Clean only with hot water extraction machine. Professional cleaning recommended
- Do not use dishwashing liquid or laundry detergent. Use only upholstery detergents
- Do not wet filling• Dry in shade away from direct heat and sunlight
- Allow to dry thoroughly before re-use

SPOT CLEANING:

- Do not rub• Do not spot clean with any solvent
- Treat spills and stains as soon as possible
- Gently scrape off any soil or blot any liquid from the surface of the fabric before applying cleaner
- Apply proprietary cleaning agents strictly according to instructions to remove the residue of the spill
- Do not saturate the fabric or interior with water or other cleaning liquids

WARNING:

Apply only water-based soil resist (fabric protection) treatments. Do not use aerosol products

* PILLING IS NOT A FABRIC DEFECT OR FAULT AND IS NOT COVERED BY WARRANTY

* PILLING IS A NORMAL OCCURRENCE IN WOVEN FABRICS AND DOES NOT AFFECT THE DURABILITY OR FUNCTIONALITY OF THE FABRIC. IT IS EASILY REMOVED BY USE OF A BATTERY OPERATED DE-PILLING MACHINE AS THE NEED ARISES